

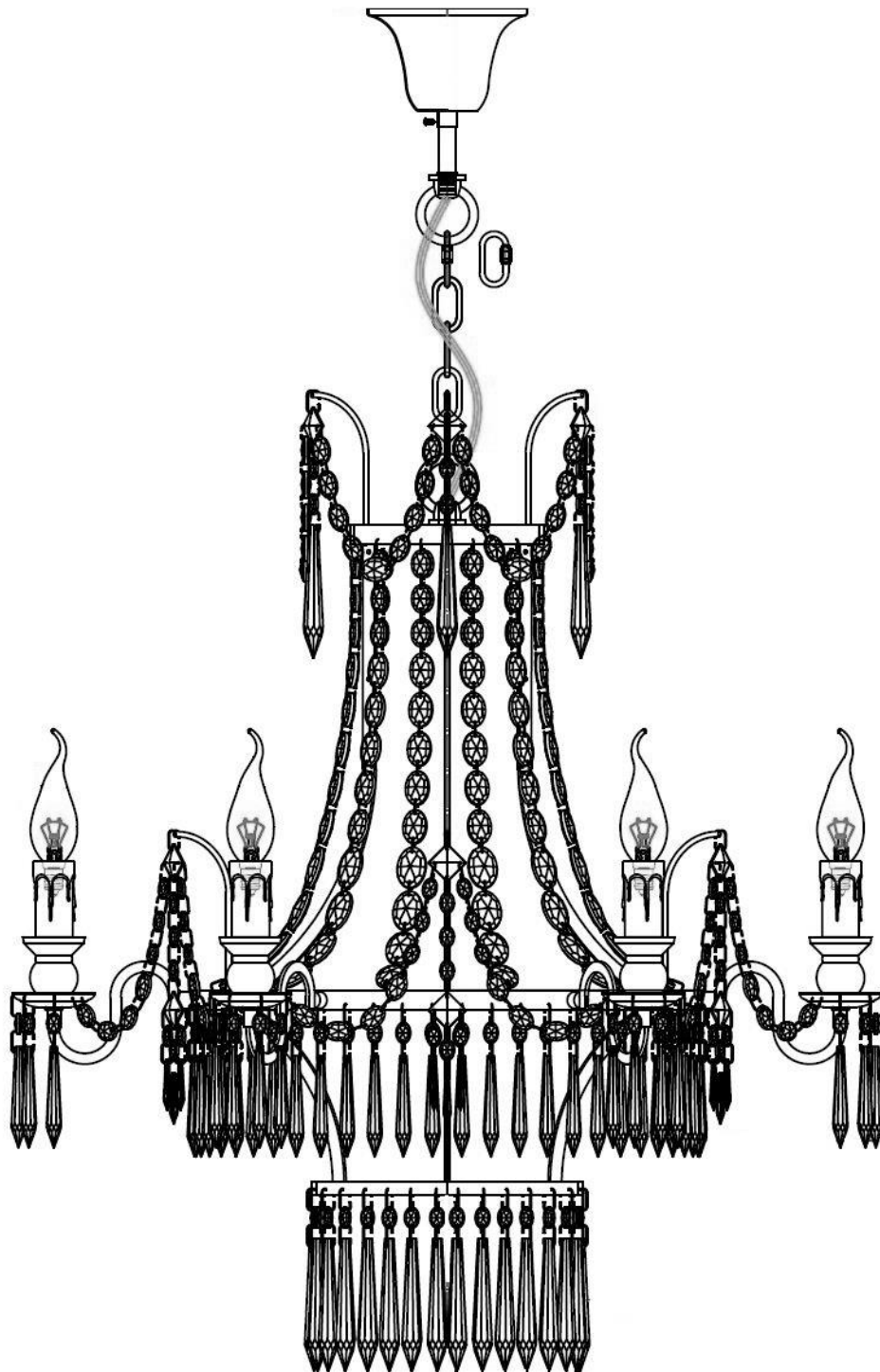

ELOQUENCE®

Maison Fondée en 2002

HENRIK CHANDELIER Assembly Instructions & Care



ELOQUENCE®

CRYSTALS & CONNECTIONS

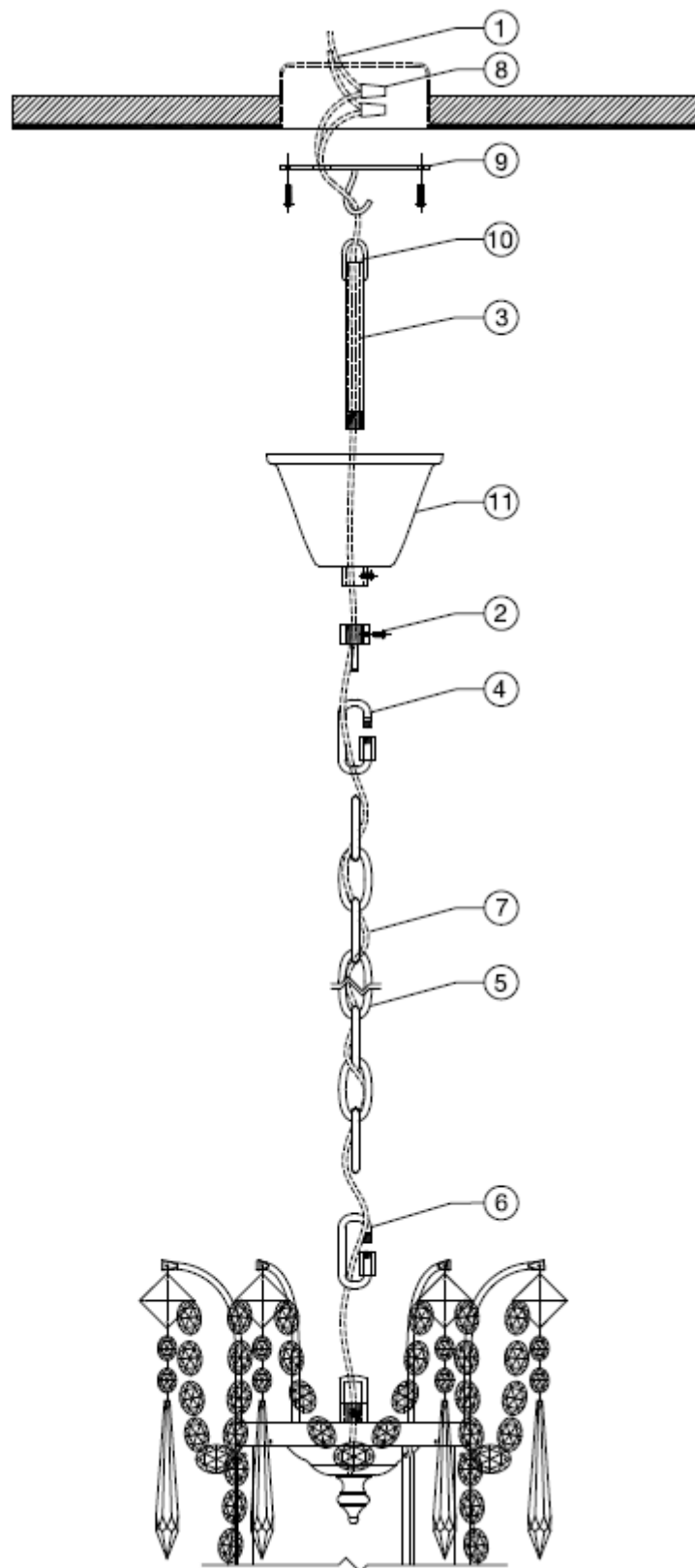

INSTALLATION INSTRUCTIONS

- 1 - SHUT OFF THE MAIN ELECTRICAL SUPPLY FROM THE MAIN FUSE BOX/ CIRCUIT BREAKER TO THE J-BOX.
- 2 - Loosen up screw on threaded loop. Twist off the loop allowing you to slip the IPS stud (#3) through the canopy. Once you complete step (#3), thread loop back onto stud.
- 3 - Feed threaded IPS stud through canopy collar.
- 4 - Connect quick link to the loop (#2) and to end of chain.
- 5 - Chain height can be custom by moving the bottom quick link (#6) up and down as necessary.
- 6 - Connect quick link at desired chain height and to the loop at top of chandelier frame.
- 7 - Feed electrical cable through the chain, canopy and match plate until reaching the J-box.
- 8 - Make proper electrical connections. This installation should be done by a qualified licensed electrician.
- 9 - Attach match plate / hook to J-box.
- 10 - Connect entire canopy, chain & chandelier frame to match plate / hook.
- 11 - Slide canopy up to ceiling line so that it covers the match plate and J-box, then tighten screw at the bottom collar.

UL LISTED

ELOQUENCE®

CRYSTALS & CONNECTIONS

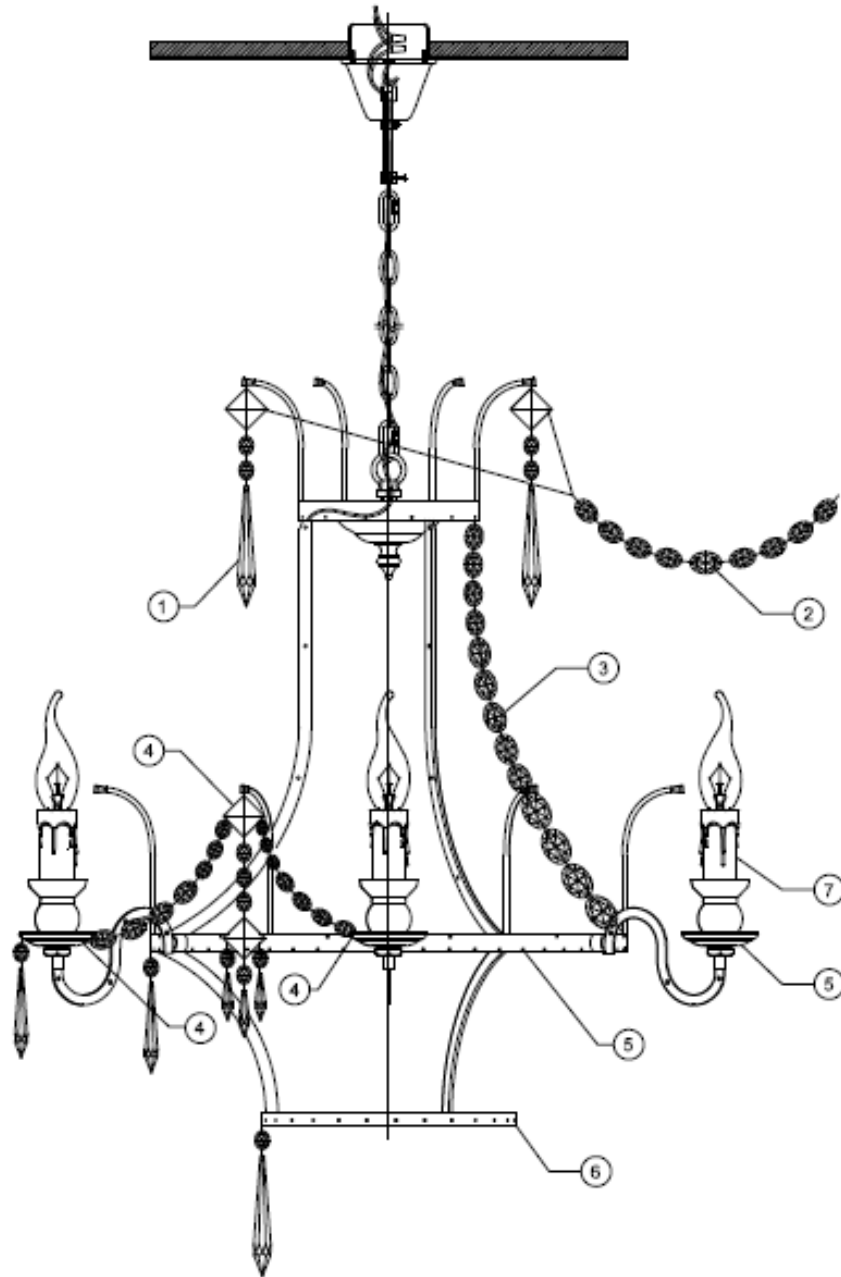







INSTALLATION INSTRUCTIONS

- 1 - Hang crystal drops from top crown as shown to the left, Pinch metal pin closed to lock in place.
- 2 - Hang crystal chain in between crystal drops at top crown, Each drop has a pin hole to the right and left of the upper diamond crystal, this is where you connect the chain. Pinch pin closed.
- 3 - Place crystal drops on center frame, in between the spaces created from step above, Place pin through hole and pinch closed,
- 4 - First, hang center drop to the metal arms attached to center cross band, Next, hang the connected chain to the right and left holes in the socket cups as shown. Pinch closed.
- 5 - Hang crystal drops from holes at bottom of center cross band, Every hole should be filled in, Pinch pin closed.
- 6 - Hang crystal drops from bottom of lower cross band, Every hole should be filled in, Pinch closed.
- 7 - Place candelabra candle cover over each socket and screw in chosen bulb up to 60 Watts max. We recommend a 25 Watt Candelabra bulb.

UL LISTED

SCREW IN CHOSEN BULBS AND
TURN ON POWER AT MAIN CIRCUIT
PANEL / BREAKER.

1	2	3	4	5	6	7
						
6pcs	6pcs	12pcs	6pcs	84pcs	27pcs	6pcs

CARE INSTRUCTIONS

To clean, wipe with a soft, dry cloth. Avoid the use of harsh chemicals or abrasive cleaners.

UL Listed, 25 watt max voltage.

Do not exceed wattage.



ELOQUENCE®
Maison Fondée en 2002

WWW.ELOQUENCE.COM
3601 Holdrege Ave.
Los Angeles, CA 90016
T: 310-876-0661 F:310-876-0667
E: INFO@ ELOQUENCE.COM