



# ELOQUENCE®

*Maison Fondée en 2002*

GENOVESE CHANDELIER

Assembly Instructions & Care



# ELOQUENCE®

HARDWARE & ELECTRICAL

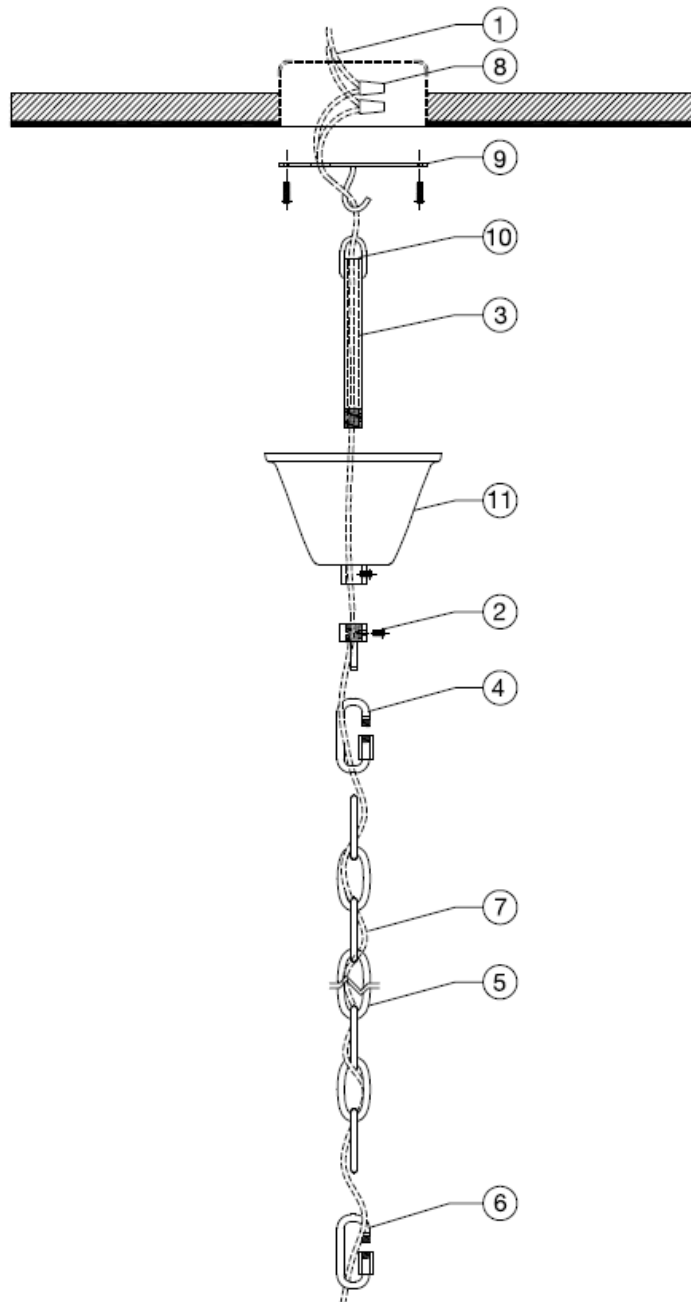

## INSTALLATION INSTRUCTIONS







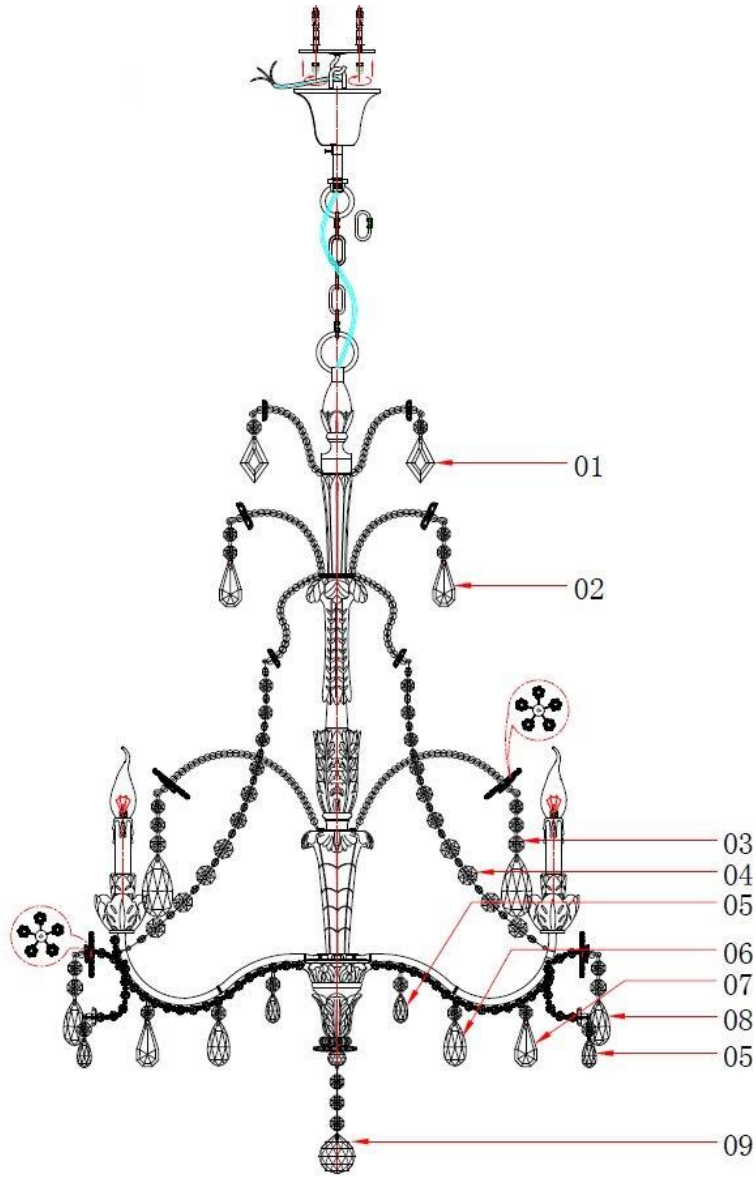

- 1 - SHUT OFF THE MAIN ELECTRICAL SUPPLY FROM THE MAIN FUSE BOX/ CIRCUIT BREAKER TO THE J-BOX.
- 2 - Loosen up screw on threaded loop. Twist off the loop allowing you to slip the IPS stud (#3) through the canopy. Once you complete step (#3), thread loop back onto stud.
- 3 - Feed threaded IPS stud through canopy collar.
- 4 - Connect quick link to the loop (#2) and to end of chain.
- 5 - Chain height can be custom by moving the bottom quick link (#6) up and down as necessary.
- 6 - Connect quick link at desired chain height and to the loop at top of chandelier frame.
- 7 - Feed electrical cable through the chain, canopy and match plate until reaching the J-box.
- 8 - Make proper electrical connections. This installation should be done by a qualified licensed electrician.
- 9 - Attach match plate / hook to J-box.
- 10 - Connect entire canopy, chain & chandelier frame to match plate / hook.
- 11 - Slide canopy up to ceiling line so that it covers the match plate and J-box, then tighten screw at the bottom collar.

UL LISTED

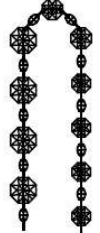
# ELOQUENCE<sup>®</sup>

CRYSTALS & CONNECTIONS



<p>01</p> <p>18#×1</p>  <p>63# Diamond bead 8 pcs</p>	<p>02</p> <p>18#×2</p>  <p>63# Rhombus 8 pcs</p>	<p>03</p> <p>18#×3</p>  <p>89# Net form 8 pcs</p>	<p>04</p> <p>24#×4+20#×2 +18#×4+12#×10</p>  <p>8 pcs</p>	<p>05</p> <p>18#×1</p>  <p>38# Net form 24 pcs</p>	<p>06</p> <p>18#×1</p>  <p>63# Net form 8 pcs</p>	<p>07</p> <p>18#×1</p>  <p>63# Rhombus 8 pcs</p>	<p>08</p> <p>18#×2</p>  <p>63# Net form 8 pcs</p>	<p>09</p> <p>18#×3</p>  <p>50# Crystal ball 1 pcs</p>
--	---	--	---	---	--	---	--	--

UL LISTED

## CARE INSTRUCTIONS

To clean, wipe with a soft, dry cloth. Avoid the use of harsh chemicals or abrasive cleaners.

UL Listed, 25 watt max voltage.

Do not exceed wattage.



ELOQUENCE®

*Maison Fondée en 2002*

WWW.ELOQUENCE.COM

3601 Holdrege Ave.

Los Angeles, CA 90016

T: 310-876-0661 F: 310-876-0667

E: INFO@ELOQUENCE.COM